

- Display Panels
- Guidelines
- Stonedust, See Detail 5/L-500

Panel placement per KlingStubbins request
 Design intent: to establish a geometrical relationship between the panels and landscape features/building façade
 Note: Landscaping not in Quatrefoil Associates scope of work

ISSUED FOR:

Graphic Concepts

Approval of the information presented indicates that **KlingStubbins** is directing Quatrefoil to proceed. In the case of "Approved as Noted", notes must also be clearly written and provide specific direction. Additional comment pages can be attached but these must contain a direct reference to this page. Information that is not approved must be specifically identified as "Not Approved", otherwise the information shall be considered approved. Note that changes requested by **KlingStubbins** that imply or result in a change to approved work may result in additional charges to **KlingStubbins** and schedule delays. **An approval box must be checked and initialed.**

APPROVAL:

Approved

Approved as Noted

Not Approved

Sample Typefaces

Physics and Chemistry

Headline
Univers Black Extended

Met lummodoledes dignisit ip ent adionul
luptat. Patem zzrilit velit lum ea feugiam.

Body Text
Univers Regular

Met lummodoledes dignisit ip ent adionul luptat.
Patem zzrilit velit lum ea feugiam vulputpat praessim
augait irit vulla facilis adio dit, eu facipit nos num.

Caption Text
New Caledonia Medium

Sample Color Palette

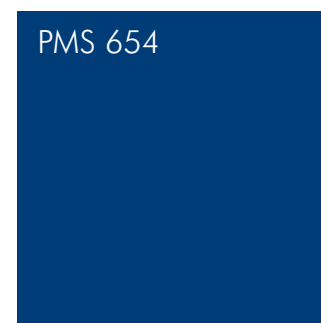
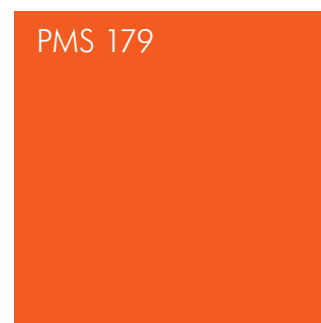
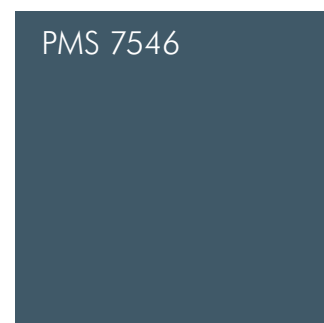
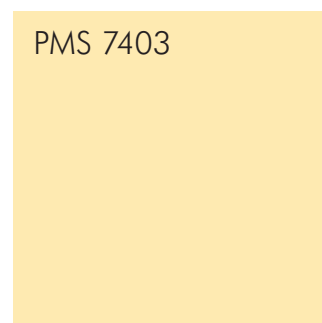
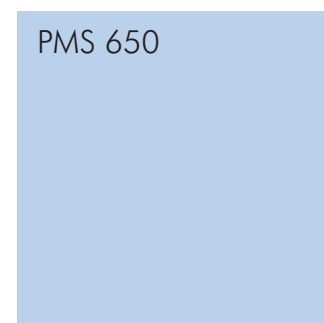

Accent Color

Accent Color



ISSUED FOR:

Graphic Concepts

Approval of the information presented indicates that **KlingStubbins** is directing Quatrefoil to proceed. In the case of "Approved as Noted", notes must also be clearly written and provide specific direction. Additional comment pages can be attached but these must contain a direct reference to this page. Information that is not approved must be specifically identified as "Not Approved", otherwise the information shall be considered approved. Note that changes requested by **KlingStubbins** that imply or result in a change to approved work may result in additional charges to **KlingStubbins** and schedule delays. **An approval box must be checked and initialed.**

APPROVAL:

Approved
 Approved as Noted
 Not Approved

Sample Layout, Panel 2

- shows fonts, colors, and hierarchy of text and images



Navy Mine Unit Building, Washington DC Naval Yard

Naval Ordnance Laboratory History

Founded as the Navy Mine Unit in 1919, the unit's mission expanded to include other naval ordnance when it moved to new facilities in White Oak, Maryland in 1946. The White Oak site was selected for the suitability it offered for one of its missions, ship magnetic silencing.



Mine and Magnetic Silencing facilities

NOL was built on 869 acres, and had about 200 buildings and facilities when it closed in 1997.

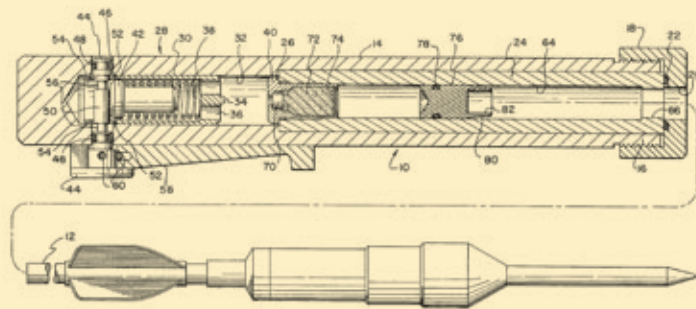

Patent for Silent Launch Gun for Projectiles, 1974

The magnetic free environment was needed to provide a setting to conduct tests on ships and mine sensors. The buildings were constructed of nonmagnetic materials like copper gutters and the sand used in the mortar was screened to eliminate magnetic elements. The instrumentation and furnishings were also magnetic free.

3,220 PEAK EMPLOYMENT

1,060 engineers, scientists and mathematicians

1,080 technicians and shop trades

1,080 administrative and clerical

Number of Navy patents based on NOL employees' work

OVER 2,000

Not to Scale: Actual Size is 40" w x 18" h

Material: 1/2" digital HPL

_____ Approved

_____ Approved as Noted

_____ Not Approved

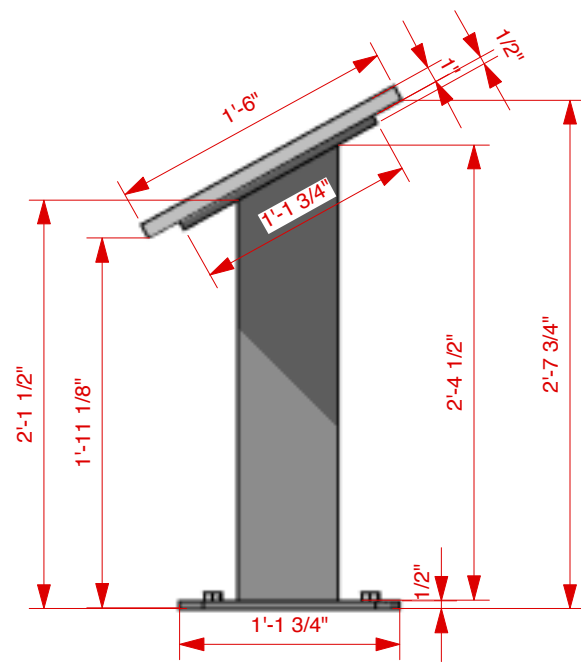

1 Side Elevation
1" = 1'

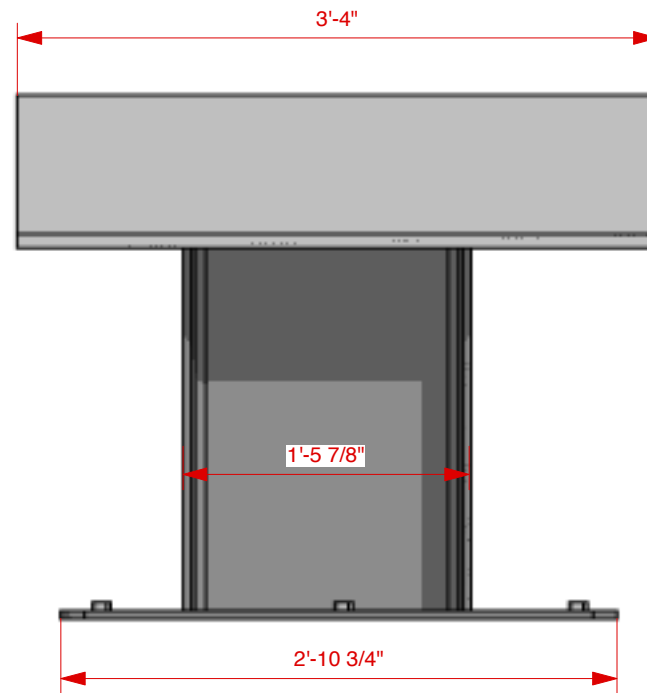

2 Front Elevation
1" = 1'

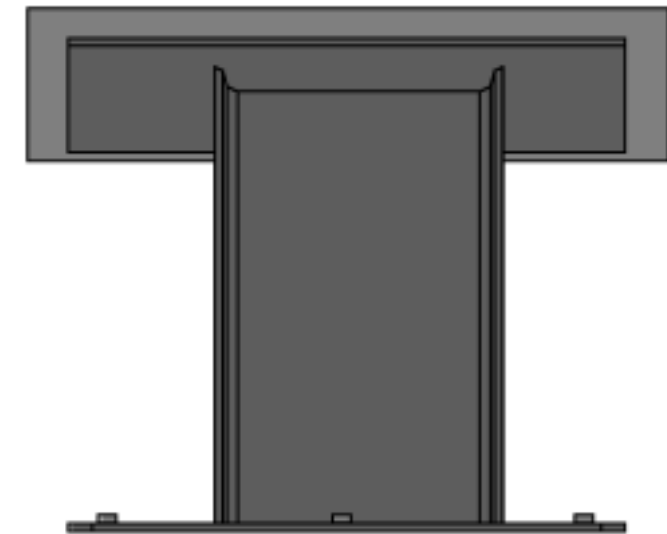

3 Rear Elevation
1" = 1'



Material: welded 1/4" steel
 Finish: gray powder coating
 Design intent: industrial/minimal, inspired by Navy battleships

ISSUED FOR:

Graphic Concepts

Approval of the information presented indicates that **KlingStubbins** is directing Quatrefoil to proceed. In the case of "Approved as Noted", notes must also be clearly written and provide specific direction. Additional comment pages can be attached but these must contain a direct reference to this page. Information that is not approved must be specifically identified as "Not Approved", otherwise the information shall be considered approved. Note that changes requested by **KlingStubbins** that imply or result in a change to approved work may result in additional charges to **KlingStubbins** and schedule delays. **An approval box must be checked and initialed.**

APPROVAL:

Approved

Approved as Noted

Not Approved